

Bending Plate HSWIM Product Specification

MS001-503510-40

19 August 2012

Issue 3



Contact: www.mikros.co.za e-mail: mikros@mikros.co.za

Bending Plate HSWIM Product Specification

Document Number	MS001-503510-40	Issue:	3
------------------------	------------------------	---------------	----------

Revision History

Issue	Author	Date	Reason for Change	Authorised
1	RS	25 Oct 2009	Initial copy	CS
2	RS	19 Jan 2010	RAKTEL8010	CS
3	RS	19 Aug 2012	Revision page added	CS

Contact: www.mikros.co.za e-mail: mikros@mikros.co.za

Introduction

Mikros Systems allows for third party bending plate Weigh In Motion (WIM) sensors to be used with the RAKTEL 8010 traffic event logger. Presently the PAT bending plates have been successfully integrated with the RAKTEL system.

The Mikros Systems RAKTEL-8010 is a major upgrade from the RAKTEL-8000 enhancements includes:

- Increased loop sensitivity
- Improved piezo axle detection
- Enhanced classification
- Expanded sensor diagnostics
- New power management

This option provides the users of Mikros Systems RAKTEL equipment the flexibility to use bending plates and have all the features of the RAKTEL system available to them.

The main components of the Mikros Systems High-Speed-Weighing-In-Motion (HSWIM) system that incorporates third party bending plates are the following:

- A RAKTEL 8010 traffic event logger (illustrated on the cover)
- Inductive loops (two per lane)
- Bending plate weigh sensors (one or two per lane) (illustrated on the cover)
- Optional piezo axle detectors to enhance detection of very light axles and provide detection of axles in lanes where no WIM sensor is installed.

The Mikros Systems RAKTEL 8010 is the primary traffic data logger for all the Mikros Systems road traffic data logging options, ranging from simple single loop traffic volume counts to complex High-Speed-Weighing-In-Motion applications.

The RAKTEL 8010 comes in a standard 19" 3U rack mount. Modular card configuration allows for flexible configuration and easy use.

The primary sensor of the RAKTEL 8010 is a high performance eight-channel digital loop detector. This detector is cross-talk free and can be used over a wide range of inductances. Each RAKTEL 8010 can accommodate up to two of these loop detectors. Vehicle volumes can be monitored for eight lanes using one loop detector, if the single loop per lane configuration is used. When vehicle speeds are also required, two loops per lane must be used. This means that up to eight lanes can be monitored (vehicle volumes and speeds) if two loop detectors are used.

By adding secondary sensors to the RAKTEL 8010 more information is recorded and more detailed classification can be undertaken. The classification of information is limited to vehicle length and inductive profile parameters when only loops are used. By adding axle detectors and/or weigh sensors, classification schemes based on axle spacing parameters can be added.

Traffic data is recorded for each individual vehicle and stored in a non-volatile memory in either the complete individual vehicle record or in a fixed summary format. It is also possible to store individual records and data summaries together. Data on all heavy vehicles can be stored as individual records and data on light vehicles can be summarized in hourly speed-volume-headway bins. The RAKTEL allows the user to select and suppress information to be stored.

The RAKTEL 8010 reports and stores comprehensive diagnostics on the logger performance and all the sensors connected to the logger.

Communication to the RAKTEL 8010 is primarily provided through two serial ports that function completely independently from each other. The RAKTEL 8010 is controlled and configured via the serial ports. RAKTEL 8010 can be addressed in a party line configuration where one line can be daisy chained to a number of loggers. The RAKTEL 8010 can also be used in L/WAN configurations using TCP/IP.

RAKTEL 8010 is supported by a suite of programs that communicates with the logger. The programs are used to control the logger and to process the collected data.

Inductive loops are always used as primary sensors with Mikros Systems' Axle Classifier traffic logging equipment. This is because loops are the most reliable sensors available.

Major features of the bending plate HSWIM Traffic Logging system

The Mikros Systems Axle Classifier Logging system has the following features to its advantage:

- A modular design.
- Flexible configuration.
- The system adheres to ASTM specifications.
- **High performance cross-talk free digital loop detector.**
- Digital chassis height detection.
- **Anti-coincidence algorithms (lane straddle detection).**
- **Tidal flow and reverse direction recording.**
- Seamless interface to third party bending plate WIM sensors
- Comprehensive system performance monitoring.
- Detail sensor diagnostics capability.
- User-friendly set-up and complete diagnostics.
- Full range of classification algorithms.
- Provision for most popular data formats.
- User-modifiable parameter sets.
- Comprehensive software support.
- Low power-consumption (solar charging supported).

Sensor configuration options

It should be noted that the configuration options chosen for a specific logger determine the sensor configuration. Each logger is configured for a specific application; therefore not all the interfaces are automatically included. Typical loop dimensions are 100cm x 300cm, spaced apart 200cm (other dimensions can also be used).

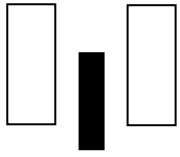
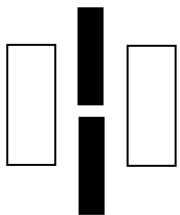
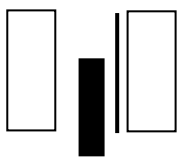
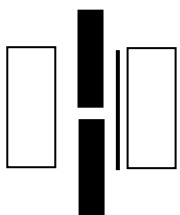
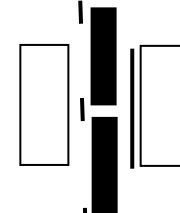
Sensor Configuration	Remarks
	<ul style="list-style-type: none"> ▪ Dual Loop plus single bending plate weigh sensor. ▪ Used for HSWIM information. Classification is based on axle spacing profiles. ▪ Up to 8 lanes can be monitored. Information on individual vehicles and/or time sliced summaries is available.
	<ul style="list-style-type: none"> ▪ Dual Loop plus dual bending plate weigh sensors. ▪ Used for HSWIM information. Classification is based on axle spacing profiles. ▪ Up to 8 lanes can be monitored. Information on individual vehicles and/or time sliced summaries is available.
	<ul style="list-style-type: none"> ▪ Dual Loop plus single bending plate weigh sensor and a piezo axle detector. ▪ Used for HSWIM information. Classification is based on axle spacing profiles. Piezo detector is used to detect light and axles not passing over the WIM sensor. ▪ Up to 8 lanes can be monitored. Information on individual vehicles and/or time sliced summaries is available.
	<ul style="list-style-type: none"> ▪ Dual Loop plus dual bending plate weigh sensor and a piezo axle detector. ▪ Used for HSWIM information. Classification is based on axle spacing profiles. Piezo detector is used to detect light. ▪ Up to 8 lanes can be monitored. Information on individual vehicles and/or time sliced summaries is available.
	<ul style="list-style-type: none"> ▪ Dual Loop plus dual bending plate weigh sensor and a piezo axle detector. ▪ In addition up to three off-scale sensors can be accommodated to enhance weigh results. ▪ Used for HSWIM information. Classification is based on axle spacing profiles. Piezo detector is used to detect light. ▪ Up to 8 lanes can be monitored. Information on individual vehicles and/or time sliced summaries is available.

Note that the RAKTEL can accommodate staggered WIM sensors inside and outside of the loop area.

Off-scale sensors are used to minimize the possibility of manipulation by drivers that deliberately try to avoid WIM sensors.

Typical configurations and optional extras

Typical configurations and optional extras for the RAKTEL 8010 bending plate HSWIM are set out below:

Standard interfaces:

- CPU
- RAKMAN power supply card
- Loop detector card (8 channel) – up to two cards per system.
- Weigh processor card (4 channel) – up to four cards per system.
- External memory card.
- Piezo axle detector card (8 channel) – up to two cards per system.

Memory options: (all memory is battery backed-up)

- 128Kb – 917Kb on the CPU card only.
- External memory (2, 4Mb or 8Mb)

Optional extras:

- Tamper alarm.
- Modem power control card.
- Overload alarm system.
- Incident output.

Short descriptions of interfaces:

CPU

The CPU card contains the processor, optional data storage memory. The memory on the CPU cannot be used with the external storage memory.

RAKMAN power supply

The power supply card can be used from 110V – 220V and also controls solar charging. The system is a 12V dc system.

Loop detector

The loop detector card is a high performance digital 8-channel unit. Up to two can be installed in a system.

Weigh processor

The weigh processor controls 4 bending plate weigh sensor inputs. Up to four can be installed in a system for a total of 16 channels.

External memory

The external memory card is a battery backed-up mass memory card that is available in either 2,4Mb or 8Mb.

Piezo axle detector

The piezo axle detector card is an 8-channel unit for detecting axle events. Up to two can be installed in a system.

Tamper alarm

A tamper alarm can be fitted in the housings. The status can be monitored remotely if the alarm is triggered.

Modem control card

The modem control card supplies power to an external modem. The power to the card can be software controlled. The power can be set up in a number of selectable time-slots. This feature optimizes power consumption and prolongs battery life.

Overload alarm system

Preset overload values can be controlled. External triggers can be switched on when an overload condition has been detected.

Incident output

In addition to the overload alarm system, incidents such as speeding can be flagged and output triggers generated. An optional 'Flash' unit is available.

Termination

All terminations of cables to the RAKTEL are done via terminal boxes. Comprehensive active lightning protection is provided on all relevant inputs.

Communication to the RAKTEL 8010

A number of communication connections (and combinations thereof) to the RAKTEL 8010 are possible. A party line is available and is handy when only one remote line is available for a cluster of RAKTEL 8010's. Each RAKTEL 8010 in the line can be assigned a unique address. It can then be remotely accessed. The limitation is that only one logger can be accessed at a time. Once the contact has been established, control is the same for all the methods mentioned below:

A: Direct on-site communication via laptop

The RAKTEL 8010 can be set up, controlled and its recorded data extracted through the TelWin program. The communication is done via a serial port.

B: Remote communication via dial-up modem

The RAKTEL 8010 can intelligently control a dial-up modem connected to it. The RAKTEL 8010 can control the power to the modem via the COMTEL interface. This feature is especially helpful when cellular modems are used that cannot go into a low power standby mode.

C: W/LAN connection via fiber optic, using TCP/IP

The RAKTEL 8010 can communicate to the TelNet program using TCP/IP. In this configuration more than one RAKTEL 8010 can be accessed at once. This can also be achieved by running more than one TelWin program.

Real-time monitoring

The following illustrates the integrated video camera function of TelWinPro.

TelWinPro can handle up to 4 cameras as synchronized input. The limitation is the actual performance of the PC that runs the program and the available hardware (frame grab cards). Cameras can be positioned to take overall and lane views and to zoom in on number plates or any configuration required.

The illustration was made using a laptop-running Windows 2000 Professional. The simple USB Web cam was used as camera. The purpose of this application was to check and verify a 'loop-piezo-loop' site.

Currently the camera is triggered from the loop activation.

The complete vehicle-by-vehicle information is synchronized with each picture. The following TelWinPro display serves as illustration:

The screenshot displays the TelWin Pro Ver 1.00B software interface. The window title is "TelWin Pro Ver 1.00B - [View RUN Files]". The menu bar includes File, Window, SiteBase, SiteInfo, SiteData, Logger, Options, Setup, and Help. The interface is divided into several sections:

- Basic Information:** Date & Time: 2004/08/31 15:35:21:000, Record No.: 1213, Physical Lane: 1, Speed: 57 km/hr, Logical Lane: 1, Length: 1620 cm, Direction: Forward, Axles: 6, Chassis Code: High, Norm.VAC: 32, Class Scheme: RSA Vehicle, Peak VAC: 56, Class: Cls 13, Occupancy: 1085 ms, Description: Six axle single trailer, Failure Code: 0, Internal Class: 28, J-Factor: 0, Tagged:
- Vehicle Data Table:**

Min	85	200	90	320	90	90	100
Act	326	138	662	136	136		
Max	200	700	265	1300	265	265	250
Min Typ	2.0	1.5	1.5		0.8	0.8	0.8
Max	5.2	7.2	5.0		5.0	5.0	5.0
Min Act Max	15.0	17.0	17.0		17.0	17.0	17.0
Min Act Max				1000			
				1620			
				2500			
- Diagram:** A schematic diagram showing the layout of the vehicle's axles and wheels.
- Video Feed:** A live video feed showing a truck on a road, viewed through a chain-link fence. The truck is a six-axle single trailer.
- Navigation and Control:** A "Which Picture" section with radio buttons for 1, 2, 3, and 4. A "Vehicles" section with "First" and "Last" buttons. A "Vehicle File" section with "Load", "Live" (checked), "Show", and "ReLoad" buttons. A "Close" button is also present.

Comprehensive system performance monitoring

One of the most powerful features of the Mikros Systems RAKTEL loggers is that it provides a continuous and visual status monitor of system and sensor performance. This greatly enhances the integrity of the recorded data. The user can see at a glance that all systems are functioning correctly. By having a long-term trace of the important system and sensor status instantly available any possible anomalies are detected immediately.

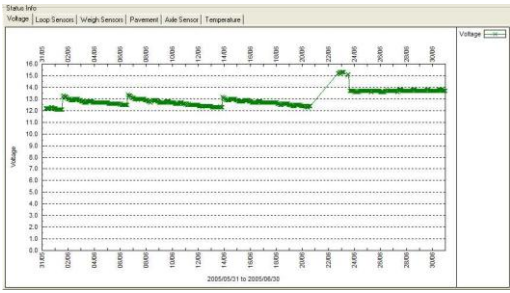
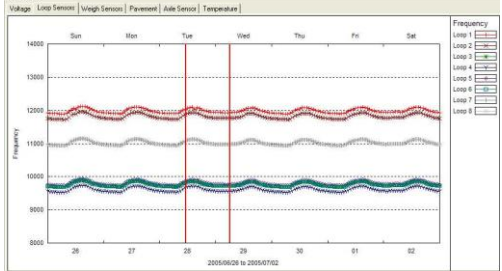
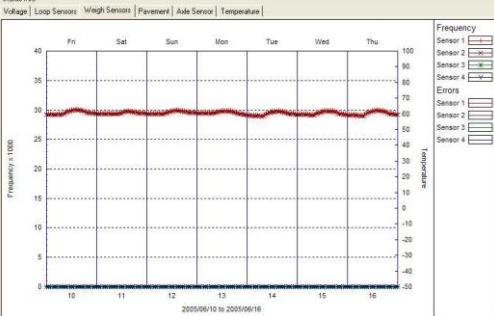
Status trace:	Comments
	<p>Continuous battery status monitored for a month.</p> <p>In this plot it can be clearly seen when batteries were changed and mains power permanently connected.</p> <p>The Y-axis indicates the current voltage.</p>
	<p>Continuous inductive loop stability (frequency) monitored for one week.</p> <p>The plot shows the normal daily fluctuations with loop errors indicated by the vertical lines.</p>
	<p>Continuous bending plate sensor stability monitored for one week</p> <p>This plot shows how the stability of the bending plate WIM sensors varies normally.</p> <p>Any deterioration of sensor performance will clearly be indicated as a abnormal deviation or erratic trend.</p>

Detailed sensor diagnostic mode

This mode is a digital scope mode that allows the user to capture detailed sensor response profiles on all of the sensors connected to the RAKTEL.

This function is used to verify the correct signals response from each sensor.

A digital trace is plotted of the response of a sensor as a vehicle passes over it. This profile can be stored for quality assurance purposes.

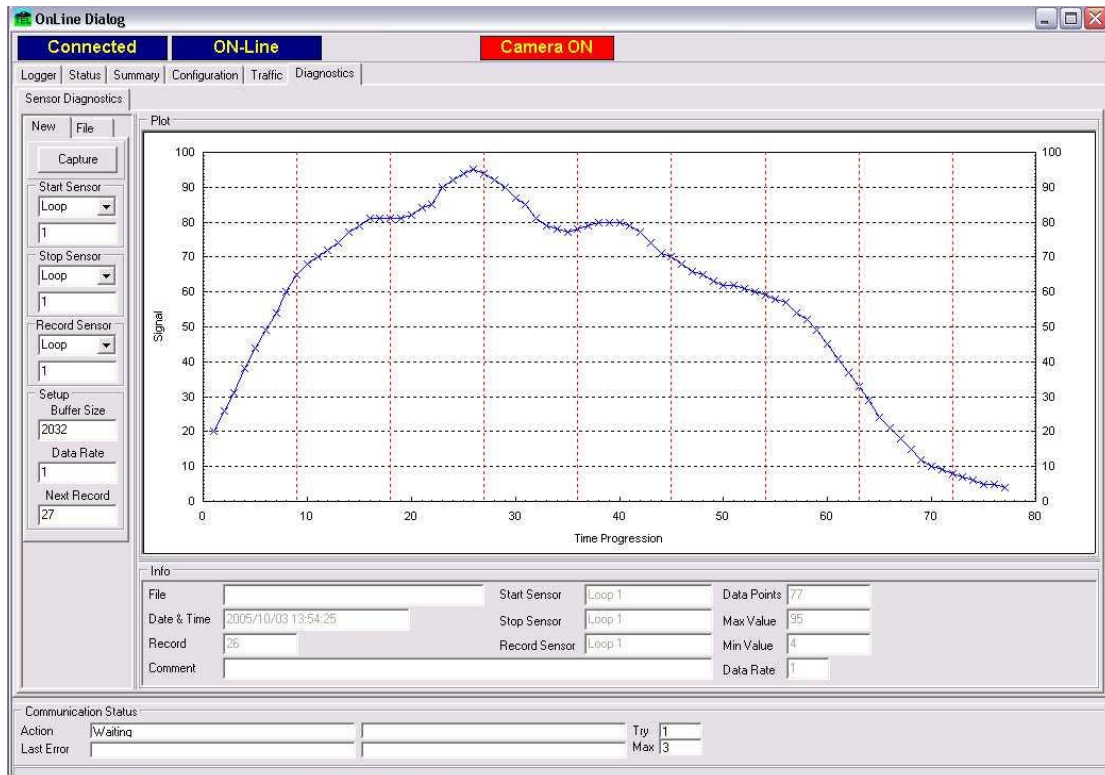

A typical sensor response of a light vehicle over a loop.

Digital vehicle chassis height determination

The loop detector provides in addition to the presence and timing signals a vehicle chassis height indication. This parameter is an automatically scaled value that is divided into three categories. The boundary values of these height categories are user selectable.

The chassis height parameter is used in the classification and coincidence algorithms of the logger.

Coincidence detection (lane straddling)

The cross talk free loop detector of the RAKTEL allows for close loop spacing between adjacent lanes (500mm typical). This makes it possible for the logger to detect a vehicle that straddles between two adjacent lanes. A requirement for this is that loops are installed abreast of each other.

This reduces double counting of vehicles on sites where lane discipline is a problem.

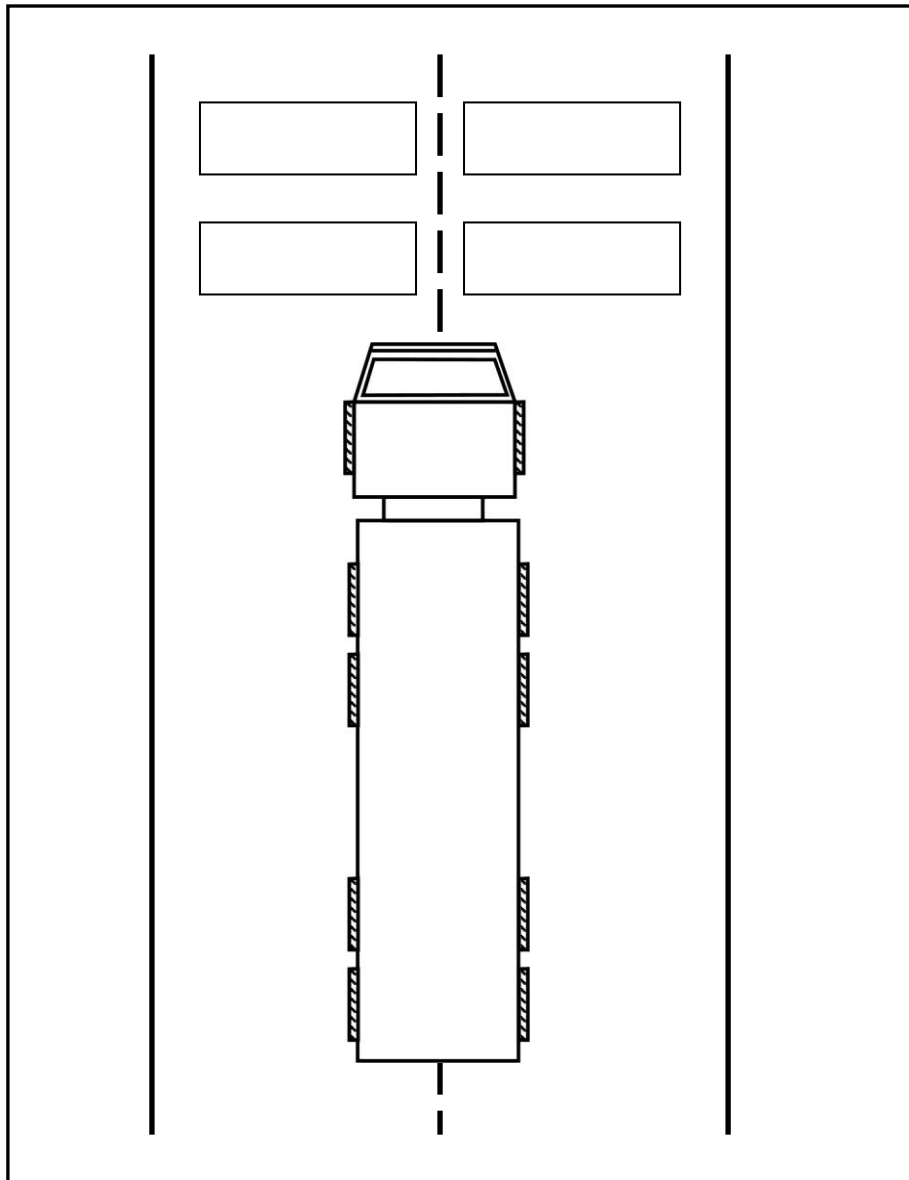

- Close loop separation allowed for.
- User selectable parameters to optimize for local conditions.
- Default standard parameter values installed.

Tidal flow and reverse direction logging

By assigning the reverse direction travel on a lane to a other than the physical lane in which a vehicle is traveling, separate logical lanes can be specified to record these incidents.

There are normally two cases where this is applicable:

1. For an undivided roadway where overtaking vehicles can drive in the reverse direction on the oncoming lane(s).

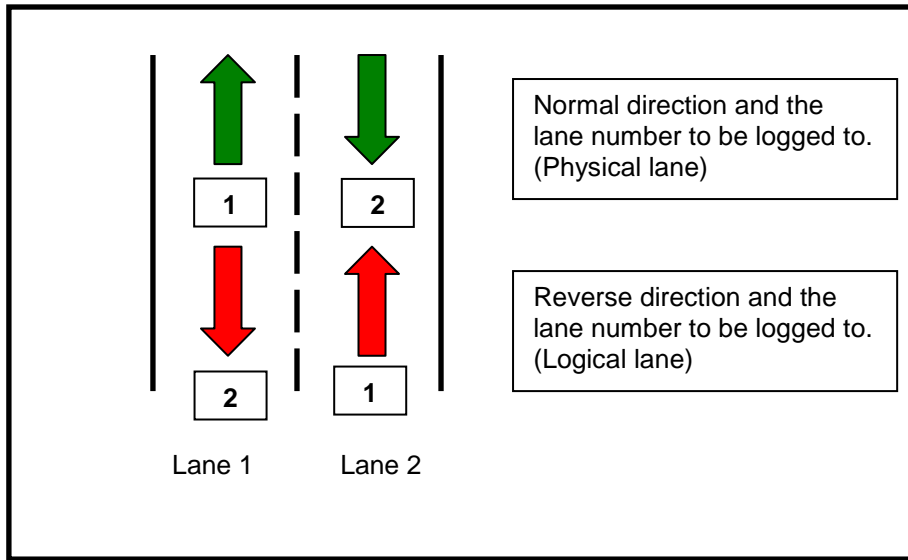

In this case a vehicle traveling in the reverse direction on lane two will be logged to lane one, and vice versa.

2. When tidal flow (or contra flow) is allowed, this can automatically be recorded by assigning separate lanes for reverse direction flow.

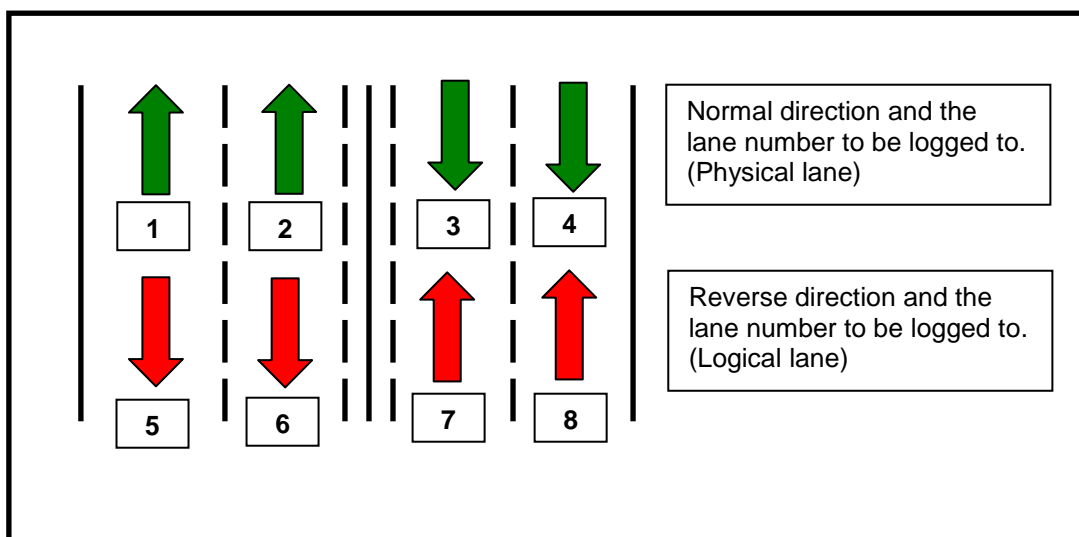

Up to a maximum of 8 physical lanes can be re-assigned for a total of 16 logical lanes.

The RAKTEL 8010 data structure

Mikros Systems uses a binary file structure in the RAKTEL 8010. Information on this structure is generally not published for two main reasons. Firstly, it allows Mikros Systems to add to the data without having to keep track of backward compatibility. It therefore simplifies configuration control. Secondly, the binary or so-called 'image' information can be used as an integrity check on the recorded data. The 'image' data contains the complete record of the recorded traffic data as well as the complete set-up information of the logger and comprehensive hardware status information (sensors, power, memory and communications parameters). In addition to this, any error that may occur during logging is 'injected' into the 'image' data when it occurs.

The 'image' data is translated into the most popular standard text formats (e.g. the US Federal Highway Association's card types and the RSA Standard Traffic Data Collection Format). Mikros Systems also provides standard formats (TXT and XTX). These formats are completely documented.

Data recording modes

The basic mode of data recording is to record individual vehicle-by-vehicle (VBV) information.

The following basic information is typically recorded:

- Departure date and time to the nearest 1/10th of a second
- Physical Lane of travel
- Re-assigned Logical Lane of travel
- Direction in the lane of travel (forward/reverse)
- Vehicle class (for selected scheme)
 - Primary class (axle spacing)
 - Secondary class (loop information)
- Chassis height code
- Vehicle length (1/10th meter)
- Vehicle speed (km/h)
- Number of axles
- Axle spacing (cm)
- Nose to 1st axle & last axle to tail distances (cm) (on special order firmware)
- Axle and/or wheel mass (1/10th tone)

The data recording modes allow for the selected recording of vehicle information by:

- Vehicle type (light/heavy)
- Lane number
- Violation

This means that, for example, the logger can be configured so that only individual vehicle information of heavy vehicles is recorded.

The following information summaries can also be recorded (injected into the data) in addition to individual vehicle information:

- Class summaries
- Speed bin summaries
- Vehicle length bin summaries
- Headway bin summaries

This can be recorded per time interval (1- 60 minutes, in whole fractions of 60 minutes).

Classification schemes supported by RAKTEL 8010

The Mikros Systems Bending Plate HSWIM system supports most of the popular classification schemes namely:

- US FHWA (FH in symbol map)
- Australian Roads Department (AU in symbol map)
- United Kingdom (UK in symbol map)
- European (EU in symbol map)
- South African (SA in symbol map)
- Hungarian

In addition to these standard schemes the expert user can also adjust parameters to adapt to local conditions.

The following classification schemes are officially supported in RAKTEL 8010:

Composite Table of Vehicles

2 Axles	3 Axles	4 Axles	5 Axles	6 Axles	7 Axles	8 Axles	9 Axles	10 Axles	11+ Axles
(1) \$21 01 02 01 01	(6) \$32 02 04 01 03	(12) \$42 02 04 01 03	(22) \$19 08 15 10 12	(28) \$1A 09 17 11 13	(30) \$1D 11 19 13 16	(33) \$1D 11 19 13 17	(35) \$3D 10 19 13 17	(40) \$1D 11 19 13 17	(45) Double Road Train \$4D 11 19 13 17
(2) \$22 01 02 01 02	(7) \$53 01 02 01 02	(13) \$53 02 04 01 03	(23) \$39 08 10 06 12	(29) \$2C 09 25 11 15	(31) \$3A 09 19 13 16	(34) \$2D 10 19 13 17	(36) \$2D 10 19 13 17	(41) \$2D 10 19 13 17	(46) Triple Road Train \$5D 12 19 13 17
(3) \$43 01 02 02 02	(8) \$43 02 04 01 03	(14) \$73 02 04 01 03	(24) \$28 08 24 06 14	(30) \$3C 09 16 09 15	(32) \$2D 09 19 13 16	(47) \$3D 10 19 13 17	(37) \$1D 11 19 13 17	(42) \$3D 10 19 13 17	
(4) \$64 03 18 12 04	(9) \$64 04 18 12 06	(15) \$84 05 23 12 06	(25) \$69 08 16 09 12	(40) \$4C 09 17 11 13	(36) \$4D 09 19 13 16	(63) \$4D 09 19 13 17	(38) Double Road Train \$4D 11 19 13 17	(43) Double Road Train \$4D 11 19 13 17	
(5) \$35 03 05 02 05	(10) \$28 05 12 07 09	(16) \$37 05 07 04 08	(26) \$42 02 24 01 03	(61) \$5A 09 16 09 13	(37) \$6C 10 16 09 10	(64) \$8D 09 19 13 17	(38) Triple Road Train \$8D 12 19 13 17	(44) Triple Road Train \$8D 12 19 13 17	
	(11) \$16 04 06 03 08	(17) \$28 04 06 10 08	(27) \$53 02 24 01 03	(62) \$6C 10 16 09 10		(65) \$5D 11 13 15 17			
	(18) \$38 05 08 05 07	(18) \$87 05 07 04 08	(53) \$64 04 18 12 10	(53) \$54 04 18 12 10					
	(48) \$78 04 19 13 08	(19) \$18 07 13 10 08	(57) \$20 08 10 06 11						
	(50) \$64 04 18 12 06	(20) \$48 07 06 05 09	(54) \$79 06 00 05 12						
	(49) \$86 05 18 12 06	(21) \$68 07 06 05 07							
		(51) \$64 04 18 12 06							
		(55) \$64 04 18 12 06							
		(82) \$88 07 21 06 08							
KEY	(J Code)								
FH	Symbol								
	AU								
	UK								
	EU								
	SA								

Installation procedure

The Mikros bending plate WIM sensor is secured to a special mounting frame that requires a recess to be excavated into the pavement. The sensors can only be installed in suitable pavements. The installation procedures of the third party bending plate suppliers must be strictly adhered to. Sensors are bolted down into a frame that is secured to the pavement with epoxy grout and a number of road anchors. The sensor is installed perfectly flush with the road surface.

The PAT bending plate requires that a minimum excavation depth of 120 mm be available in the pavement.

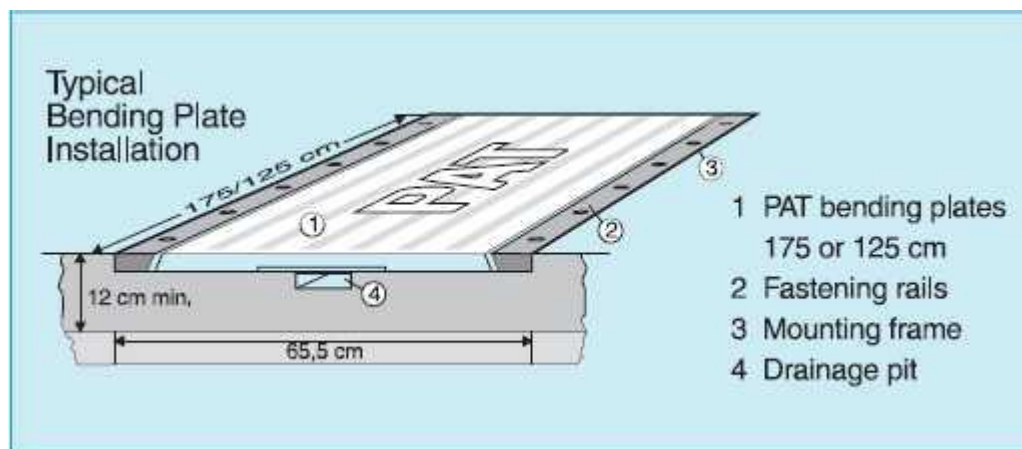

Diagram of installation:

Typical housings

A number of housings are available to suit the local conditions. Since the RAKTEL 8010 is a standard 19" rack it can be housed in any standard 19" rack system. The picture below serves as illustration:



A more secure housing can be used at sites where security is a concern. The picture below serves as illustration:



Internal heating is provided in cold climates where condensation is a problem. The following picture serves as illustration:



Summary of RAKTEL 8010 specifications

<ul style="list-style-type: none"> • Sensor inputs <ul style="list-style-type: none"> Primary sensors Secondary sensors 	<p>8 Channel self tuning loop detector (up to 16 channels)</p> <ul style="list-style-type: none"> - 8 Channel axle detector - 4 Channel WIM interface (piezo, capacitive or bending plate) up to 16 channels - 8 channel I/O card
<ul style="list-style-type: none"> • Multiple Logging Modes <ul style="list-style-type: none"> Individual and/or data summaries (in metric or imperial units) Data summaries 	<p>Basic information captured:</p> <ul style="list-style-type: none"> - Arrival time (one tenth of a second) - Lane on travel - Direction in lane (reverse direction logging) - Vehicle speed - Chassis profile - Vehicle length - Axle spacing - Axle weight - Classification code (Selectable, FHWA, and other) <ul style="list-style-type: none"> - Variable logging period (1 to 60 minutes) - Lane summaries - Classification bins - Speed bins (up to 20) - Weight bins (up to 20) - Headway bins (up to 20) - User pick list and data suppression table
<ul style="list-style-type: none"> • Memory options 	<ul style="list-style-type: none"> - Up to 8Mb battery backed-up RAM
<ul style="list-style-type: none"> • Control, data extraction and communication 	<ul style="list-style-type: none"> - Two RS232 ports (300 – 19 200 baud) - Local via laptop - Remote via modem, network or direct fiber links
<ul style="list-style-type: none"> • Diagnostics 	<ul style="list-style-type: none"> - Complete local and remote sensor & system status - Dynamic sensor diagnostics
<ul style="list-style-type: none"> • Power management 	<ul style="list-style-type: none"> - High efficiency solar charge regulator - Mains power supply and charger (110V – 220V) - 12V DC - 5.5 - 7 Watt (nominal dependant on number of WIM sensors) - External power (300mA) to ancillary devices (2) - Hot-swap battery plugs
<ul style="list-style-type: none"> • Temperature range 	<ul style="list-style-type: none"> - - 20°C to 65°C
<ul style="list-style-type: none"> • Weight and dimensions 	<ul style="list-style-type: none"> - Standard 19" 3U rack - 490mm x 320mm x 140mm - 7,8kg - 10 slots maximum
<ul style="list-style-type: none"> • Options 	<ul style="list-style-type: none"> - Modem control & lightning surge protection - Expanded memory - Contact closure outputs from loops - Violation outputs
<ul style="list-style-type: none"> • Support software 	<ul style="list-style-type: none"> - TelWin & TelWinPro for logger set-up, control and data conversions to popular data formats such as FHWA card types. Also exports to data bases and spreadsheets. - TelNet for network applications (incident detection and ramp metering) - TelDial automatic list dialer - TrafBase extended data validation, storage, archiving and reporting program.

Summary of HSWIM specifications

Dual Bending Plate Weigh Sensor Per Lane (Open road applications)	ASTM E1318 Type I
Weighing accuracy (site dependant)*	Wheel mass 25% Axle mass 20% Axle group load 15%
Values for 2σ	GVM 10% Not better than $\pm 300\text{kg}$
Axle spacing: (1σ)	150mm
Speed range	5km/h – 130km/h
*Sites must conform to standard ASTM 1318 type I pavement compliance requirements. Under normal free-flowing traffic conditions.	
Maximum axle load	20 000kg
Temperature range	-20°C to 65°C
Dimensions	Bending plate sensor: 1 750mm x 508mm x 23mm / 114 kg 1 250mm x 508mm x 23mm / 81 kg
Material	Alloy vulcanizes with special compound
Excavation requirement for sensor	Depth of 120mm

Single Bending Plate Weigh Sensor Per Lane (Open road applications)	<p>ASTM E1318 Type I specification achieved when trucks are symmetrically loaded.</p> <p>ASTM E1318 Type II specification achieved when wheel loads differ (only one side has been measured).</p>
--	---

Mikros Systems reserves the right to change product specification at any time without prior notice. Mikros Systems has no control over any third party product changes and all reference to such third parties is done in good faith and with out any prejudice.